

500 Series

500

Pitch 50,8 mm
H= 24 mm

Imperial Size



500 RR
500 RR *with positioner*
389 *Combs*

Movex®

500 RR

Tappeti modulari / Modular belts / Mattenketten

Belts wider than standard are available with 3 inch increments



Imperial Size

500 RR

Tappeto Modulare 500 RR
Raised Rib Belt Series 500 RR / Modulare Mattenkette 500 RR

CODE STRUCTURE GUIDE (Example)

1348	02	0060
Series	*Material	Width

	
pg. 333-334	pg. 651>661



50.8mm
PITCH

*Material

PP - Code 02 Polypropylene	PPX - Code 11 Polypropylene
Max w. load: 30000 N/m	Max w. load: 30000 N/m
Weight: 10,65 kg/m ²	Weight: 10,65 kg/m ²
Temp. range: 4+104 °C	Temp. range: 4+104 °C
Pin material: PP grey	Pin material: PP grey

IMPROVED HEAT STABILITY

Series	Material	Width
1348	*	0060
1348	*	0063
1348	*	0066
1348	*	0069
1348	*	0072
1348	*	0075
1348	*	0078
1348	*	0081
1348	*	0084
1348	*	0087
1348	*	0090
1348	*	0093
1348	*	0096
1348	*	0099
1348	*	0102
1348	*	0105
1348	*	0108
1348	*	0111
1348	*	0114
1348	*	0117
1348	*	0120

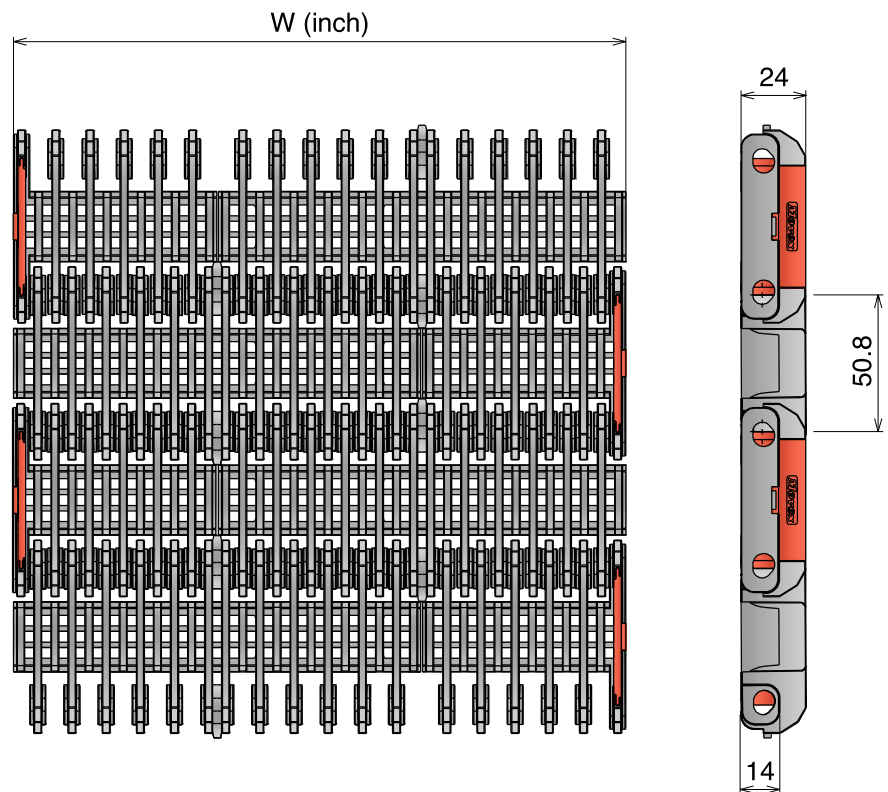

Tappeti modulari / Modular belts / Mattenketten

500 RR with positioner

Tappeti modulari / Modular belts / Mattenketten

Belts wider than standard are available with 3 inch increments

NEW 500 RR with positioner Tappeto Modulare 500 RR Raised Rib Belt Series 500 RR / Modulare Mattenkette 500 RR

Imperial Size

CODE STRUCTURE GUIDE (Example)

1348	02	0060	C
Series	*Material	Width	Version

50.8mm
PITCH



pg. 333-334



pg. 651>661

*Material

PP - Code 02
Polypropylene

PPX - Code 11
Polypropylene

Max w. load:	30000 N/m	Max w. load:	30000 N/m
Weight:	10,65 kg/m ²	Weight:	10,65 kg/m ²
Temp. range:	4+104 °C	Temp. range:	4+104 °C

Pin material: PP grey **Pin material:** PP grey

IMPROVED HEAT STABILITY

Series	Material	Width	Version
1348	*	0060	C
1348	*	0063	C
1348	*	0066	C
1348	*	0069	C
1348	*	0072	C
1348	*	0075	C
1348	*	0078	C
1348	*	0081	C
1348	*	0084	C
1348	*	0087	C
1348	*	0090	C
1348	*	0093	C
1348	*	0096	C
1348	*	0099	C
1348	*	0102	C
1348	*	0105	C
1348	*	0108	C
1348	*	0111	C
1348	*	0114	C
1348	*	0117	C
1348	*	0120	C

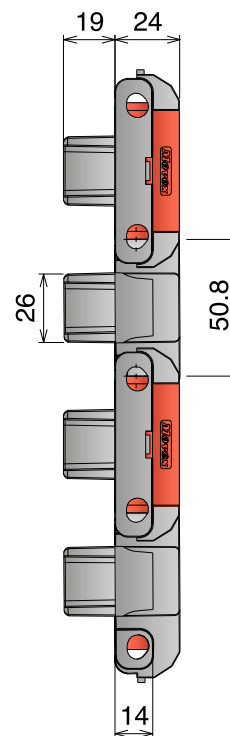
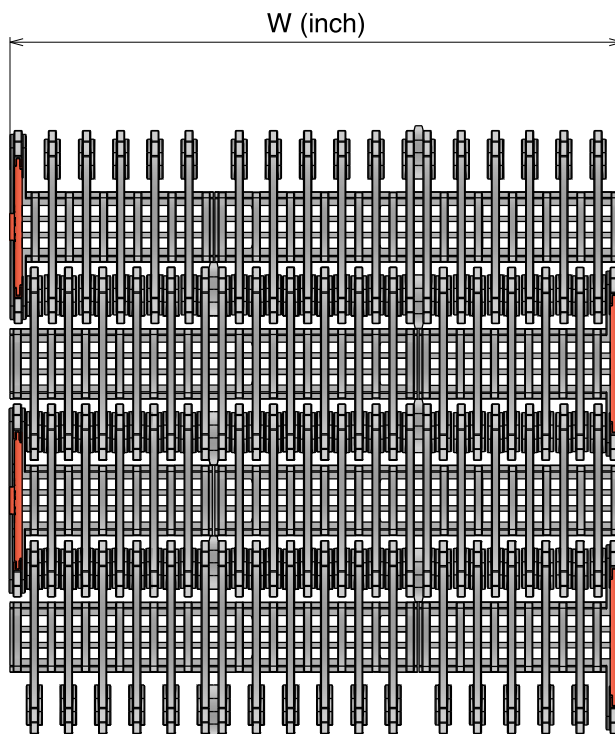

Bottom view

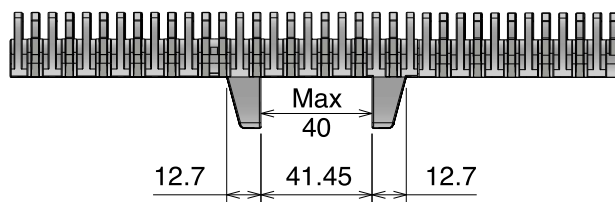

For belt widths multiple of 3", positioners are centered (e.g. 63,69,75,81 inches).
For belt widths multiple of 6", positioners are 1,5" offset (e.g. 60,66,72,78 inches).

389 Pettine Combs / Fingerplatte

Two screw included

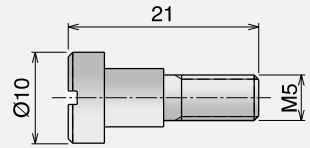

For assembly instructions refers to Movex engineering manual available on our website.

Type A

Part	Article-Nr.
389	38901

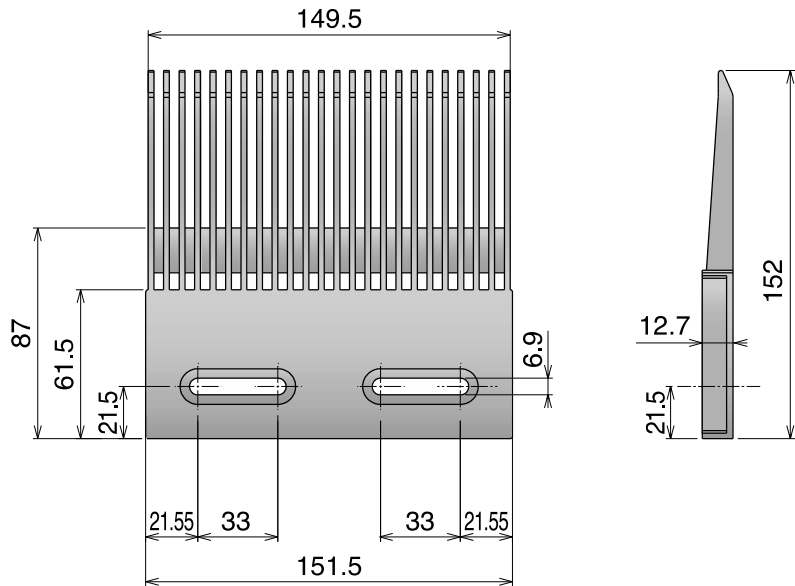

Type B

Part	Article-Nr.
389	38902

